

# FBX<sup>®</sup>

---

# SOLO

## OPERATING GUIDE



**FBX-SOLO Model SL820**



**FBX-SOLO Model SM820**

## TABLE OF CONTENTS

- Front Panel Description 5
- Back Panel Descriptions 6 - 7
- Applications for Use 8 - 9
- Before you Begin... 10 - 13
- Operating Instructions 13
- FBX Setup Instructions 14 - 18
- Trouble Shooting Tips 18 - 19
- Product Specifications 20 - 21
- Warranty & Cautions 22 - 23

## QUICK START OPERATION

*For best results, read all operating instructions before using the FBX-SOLO (pages 12-19).*

1. Patch in the SOLO where appropriate for your model, and select the input/output level on the back.
2. With gain down on the input channel, put the SOLO in Active mode (green bypass LED), then slowly raise the channel gain to the point of feedback.
3. Raise the gain slowly until 7 FBX filters are set, then reduce gain slightly.
4. Adjust the Clip Level on the SOLO, and you're ready to go.

**SABINE<sup>®</sup>**  
ADAPTIVE AUDIO

## CONGRATULATIONS!

You now have the state-of-the-art in feedback control. The Sabine **FBX-SOLO** gives you automatic real-time feedback control for any channel of your mix. In setup **and** during the performance, it gives you more gain and increases the clarity of your mains and monitors. It's the affordable solution to feedback problems, perfect for wireless mics, monitors, acoustic/electric instruments, harmonica mics, multi-mic locations like conference rooms and courthouses — wherever there's an open microphone. The FBX-SOLO incorporates the latest in design and digital signal processing technology. It automatically senses feedback in a sound system and determines its pitch. It then places one of its eight constant "Q" micro-filters on the resonating frequency and eliminates the feedback in typically less than one second.

### Special features of the SL820 and SM820:

- New ultra fast **Turbo Setup Mode** grabs feedback at very low levels.
- The SL820 has **1/4" in/out connectors** and **input/output level switches** for any combination of ins and outs. The SL is for use with acoustic/electric guitars and guitar amplifiers, mixer insert points, powered mixer patch points and high impedance mics.
- The SM820, with **selectable phantom power**, has **XLR in/out connectors** for use with balanced microphones.
- Both models offer standard FBX features like **switchable filter widths** and **lockable fixed filters**.
- New improved performance - **20 bit A/D conversion**, **expanded dynamic range** & up to 8 FBX filters.

## HOW CAN THE SOLO BE USED?

Assign a SOLO to any specific mixer channel. You can also use the SM820 to connect a phantom-powered mic to a non-phantom-powered mixer.

*See SOLO Applications on page 8 & 9.*

## **THE BEST FEEDBACK CONTROLLER**

Before the invention of the FBX, the most common device for controlling feedback was the 31-band graphic EQ. However, the FBX has three distinct advantages. The most obvious is the FBX functions automatically, even during the program. Another is the FBX micro-filters are precisely placed while EQ filters are fixed; FBX filters can be placed between predetermined graphic filters. The difference: FBX filters do not have to be as deep, so there is more system gain. The final and most important advantage is that FBX micro-filters are ten times narrower than 31-band EQ filters. FBX micro-filters return up to 90 percent of the power removed by EQ filters. Over the years, engineers stopped using 12-band EQs in favor of the narrower-filter 31-band EQ for controlling feedback. The FBX represents the next step. An EQ would need more than 10,000 sliders to be equivalent to your FBX. With the SOLO, your monitors will finally sound loud enough, everyone in the audience will understand each word, and the mains will sound natural and transparent.

### **WHO NEEDS THE FBX?**

Virtually every sound system will be improved with the FBX. Small bands that do not have sound technicians can now increase their monitor volumes so they can hear themselves clearly and with full fidelity, without worrying if the program is going to be ruined by feedback.

Auditoriums and churches of all sizes will enjoy reliable feedback control. Hotels and conference centers around the world can offer meeting rooms with sound systems that won't howl during programs. The SOLO can be installed in theaters, schools, sports arenas, courtrooms — anywhere multiple microphones are used. It can also be used for teleconferencing, intercoms or interactive remote classrooms.

### **WHY THE FBX?**

The simple beauty of the FBX is its ability to quickly and effectively eliminate feedback with narrower filters than ever before possible. The FBX delivers superior sound quality automatically.

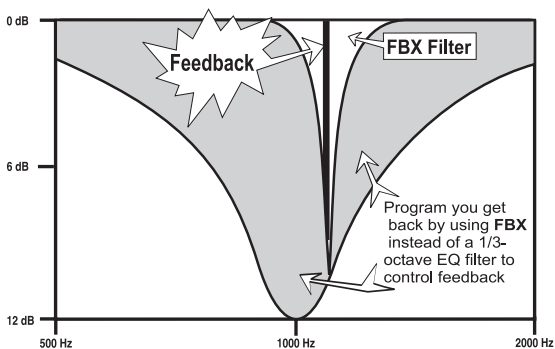

**A DIRECT HIT ON FEEDBACK!** The FBX-SOLO targets feedback without taking a big chunk out of your sound. Tests prove that a single 1/3-octave EQ slider pulled down 12 dB removes almost half the power going to the speakers over a two-octave range. And, as the illustration above shows, you can't place a graphic EQ filter precisely on the ringing frequency. When you pull down multiple sliders in a normal setup (below), you end up with giant holes in your sound. On the other hand, FBX constant "Q" micro-filters are 10 times narrower - you get back up to 90% of the power you lose with a graphic EQ! That means more gain before feedback and no loss in sound quality.

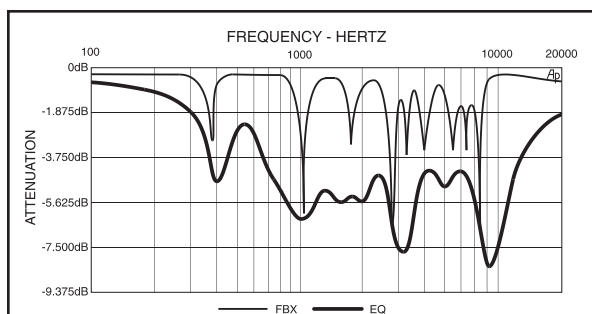

**FREQUENCY RESPONSE TEST: Full Set-Up FBX vs. 1/3-Octave Graphic Equalizer.**

Test procedure: A PA system was set up using a microphone, mixer, FBX, power amp and two speakers. The system's gain was raised until the FBX removed six feedback points. Next, the FBX was replaced with a 1/3-octave graphic EQ. The EQ was adjusted while the input was raised to the same level achieved with the FBX. The frequency response curves of each device were then plotted.

**What this means to you:** Doubling the cost of your microphones, speakers and power amp probably would not improve your system's frequency response as much as replacing your EQ with an FBX for chasing feedback.

# SL820 & SM820 FRONT PANELS

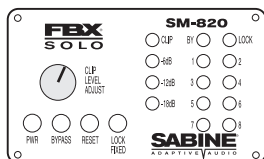
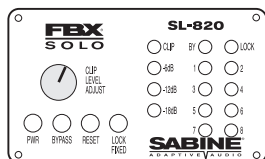

## POWER

The On/Off power switch is a two-position push button switch. The LEDs corresponding to all active filters will blink on power-up.

## ACTIVE/BYPASS

In Active mode, the unit controls feedback automatically. The two-color "BY" LED lights green when the unit is in Active mode and lights red when in Bypass mode. The mic preamp remains active in Bypass mode; only the FBX function is bypassed.

## DUAL-FUNCTION RESET

To reset only the dynamic filters, press and hold the reset button. The LEDs will flash 3 times and then the LEDs that indicate current Dynamic filter placement will shut off (fixed filter LEDs will remain on). To reset ALL filters, hold the reset button until all LEDs go off (approximately 7 flashes).

## LOCK FIXED FILTERS

When the "Lock Fixed" button is pressed, its LED will light to indicate that the FBX is in Lock Fixed mode. Lock Fixed mode can be activated at any time after system setup and will stay on until the button is pressed again and the LED turns off. The dynamic filters are not affected (see p.10 for details).

## CLIP LEVEL ADJUST

The front panel clip level adjust knob has two functions, and its use will depend on the setting of the output switch on the back panel. When the output is set to Unity: the Clip Level Adjust allows you to set the optimal clip level for the input signal, in order to optimize the dynamic range while maintaining unity gain. Higher input levels will require the Clip Level Adjust to be turned more counterclockwise to avoid distortion; lower input levels will require the knob to be turned clockwise, to minimize noise.

Recommended setting of the Clip Level Adjust: the clip LED should blink intermittently. Regardless of the Clip Level Adjust, setting Unity on the back panel will maintain unity gain (no net gain or loss of signal level).

When the back panel output is set to Line, the SOLO acts as a preamplifier, and the Clip Level Adjust knob becomes a gain control (see SL820 & SM820 Input Low/High Switch sections below).

## SIGNAL LEVEL/TURBO INDICATOR

The LED ladder indicates the signal strength relative to the SOLO's input level. Clip LED flashes independently to indicate when the SOLO is in Turbo Setup mode.

## FILTER ACTIVITY

When one of the unit's constant "Q" filters is activated, the corresponding LED lights. A blinking LED indicates the filter that was most recently activated. All filter LEDs cycle to indicate Turbo Mode is about to disengage.

## FILTER WIDTH SWITCH

Switch to narrow 1/10-octave filters for music applications or to wider 1/5-octave filters for spoken word applications. The change takes effect only on power up. Selecting a new width has no effect unless you power down and then power up again.

## 12 VOLT DC ADAPTOR

The FBX external power supply (single unit power supply; model # SPSPOWR) is included with the unit. Use of any other power supplies may cause permanent damage to the unit and **WILL VOID THE WARRANTY.**

## SL820 BACK PANEL ONLY

### INPUT LOW/HIGH SWITCH

Switch to **Low** for instrument or (high impedance microphone) IN. Use with low level inputs such as piezo mic pick ups — this provides a 30 dB boost in the FBX's input gain structure. Switch to **High** for insert or line IN: use with high level output instruments and signal processors.

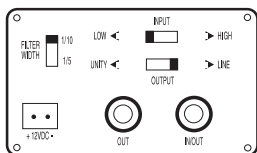

## OUTPUT UNITY/LINE SWITCH

Switch to Unity (for level in = level out) for use with amplifiers that accept low level signals, such as guitar amps. In the Unity setting, the SL820 input level equals the output level. Switch to Line (for line level out) if your signal needs pre-amplification. In the Line setting the gain is adjusted between 0 and +35 dB (High IN); +30 to +65 dB (LOW IN) via the clip level adjust.

## INPUTS & OUTPUTS

The connector labeled IN/OUT serves as both the unit's input (tip) and output (ring) when used with a single TRS plug. When used with a Y-cord, use the IN/OUT as the input and the OUTPUT as the output (for channel insert configurations).

## SM820 ONLY BACK PANEL

### OUTPUT LO/HI SWITCH

In the LO setting, the SM820 has unity gain (input = output); use LO for mic level. In the HI setting, gain is adjustable between -15 dB and +20 dB using the clip level adjust; use HI for line level, or when you need to preamp the signal.

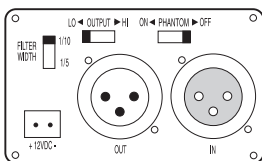

### PHANTOM POWER ON/OFF SWITCH

The SM820 is set to "Phantom Power - OFF" at the factory. If you wish to use phantom power, move the switch to "ON." **NOTE:** The SM820 will not pass phantom power from your mixer.

### INPUT

The input accepts balanced XLR-3 (PIN 2 high) plugs.

### OUTPUT

Use balanced XLR-3 plugs (PIN 2 high) for balanced mixer line inputs. **NOTE: the output impedance of the SM820 is unbalanced.**

# APPLICATIONS

**SL820:** You can use the SL820 with acoustic/electric guitars and guitar amplifiers, mixer insert points, powered mixer patch points and high impedance mics. Use the following wiring diagrams as guides for setup:



**NOTE:** For Configurations 1-4, the output control on the back panel of the SL820 may actually be set to either Unity or Line. In the Unity setting the output level will equal the input level, and, since the input level to the SL820 in such a setup is already line level, the output will be line level as well. When the output setting is switched to Line, the front panel knob becomes a gain control, and it is possible to add additional gain to your signal path, if needed. Care should be taken in this situation to avoid overdriving your mixer channel.

## 1. Mixer Channel Insert with TRS/TRS Cable

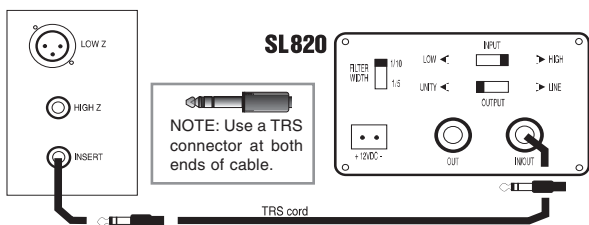

## 2. Mixer Channel Insert w/ Insert "Y" Cable

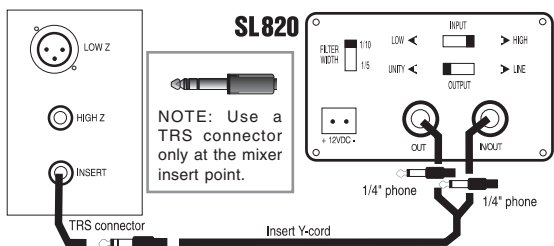

## 3. Mixer Channel HI Impedance Mic on Line Input

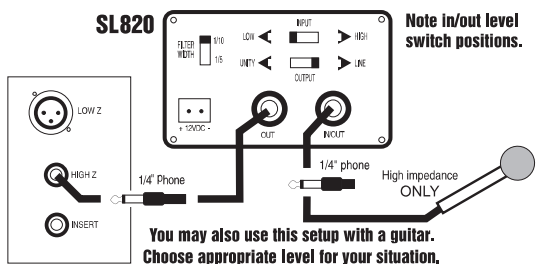

## 4. Instrument IN for Amp

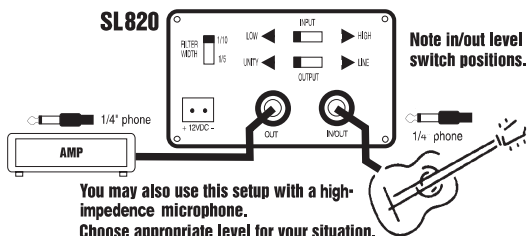

NOTE: an SL820 can be inserted at line level after the mixer and before the power amp on smaller systems.

**Note for SM820:** Use the SM820 with balanced microphones.

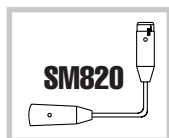

## 5. Mic Input to Mixer Line Input

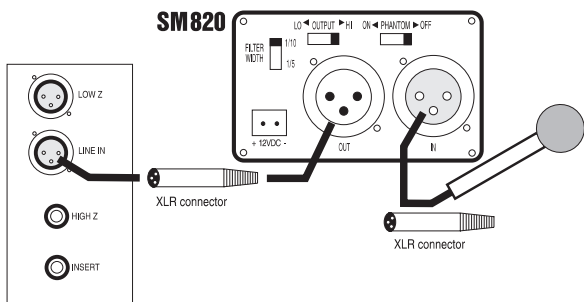

## 6. Mic Input to Mixer Mic Input

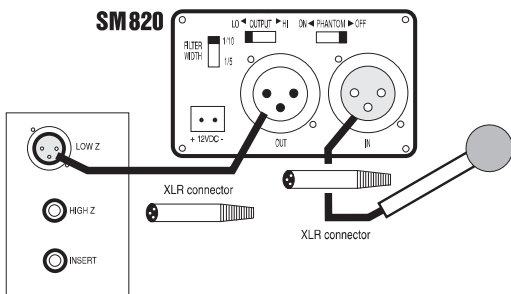

## BEFORE YOU BEGIN...

The FBX automatic feedback controller improves any sound reinforcement system. By following these simple instructions, you will be assured of the most benefit from your FBX and sound system. The instructions presume that you are familiar with the fundamentals of sound reinforcement. If any of the terms are not clear, or if the system does not perform as expected, contact your local Sabine dealer for further information. Read on for a basic explanation of FBX features you should understand before using your FBX.

### POWERING UP

When connecting the power supply to the FBX-SOLO, angle the connector down, then push the connector up into the input **gently**, with the lip facing **up** as shown. Do not force the connector into or out of the FBX.

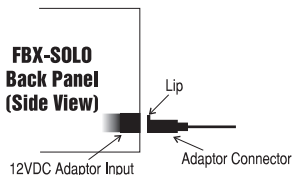

### UNDERSTANDING FIXED & DYNAMIC FILTERS

The FBX has two types of constant “Q” filters: Fixed and Dynamic. Both filters are placed the same way: feedback is detected and the filter is placed just deep enough to eliminate it. The difference between Fixed and Dynamic comes after the filter is placed. Fixed filters are set automatically during the initial setup and remain on the initially detected feedback frequency — they do not move. The system’s gain before feedback is provided by the Fixed filters; i.e., increasing the number of Fixed filters increases the system’s allowable gain before feedback.

The FBX’s Dynamic filters control intermittent feedback that occurs during the program.

*NOTE: Dynamic filters release only when necessary, i.e., after all filters have set, but a new feedback frequency has been detected. These filters will not “gradually release” as they might in other feedback controllers — leaving you unprotected and at risk of feedback. Sabine’s Dynamic filters allow for adaptive, safe, continuous feedback control during the performance.*

If Lock Fixed is not engaged, the Fixed filters will control feedback during performance on their as-

signed frequencies (configured during setup). Increased activity at one of those frequencies may cause the filter to go deeper (e.g., deepen from -12 dB to -15 dB). Activating the Lock Fix function prevents the Fixed filters from going deeper at their assigned frequencies.

## **FIXED & DYNAMIC FILTER CONFIGURATION**

The filters can be reconfigured easily from the factory default setting (six fixed and two Dynamic) to any combination of Fixed and Dynamic filters. For example, the following procedure will set three filters Fixed and five Dynamic:

1. Place the unit in Bypass mode.
2. Power down the SOLO.
3. While depressing the Reset button, power up the unit.
4. Release the Reset button. The Filter Indicator LEDs will now light in sequence.
5. When the third LED is lit, press the Reset button.
6. Notice that the first three LEDs flash three times to verify that they are now the Fixed filters. Filters which do not flash are Dynamic filters.

NOTE: The Fixed filters flash three times whenever the FBX is powered up.

## **RESET OPTIONS**

The Reset button has two functions: You can reset all the FBX filters, or just the Dynamic filters. Hold the Reset button in and all the filter LEDs will begin flashing. To clear only the Dynamic filters, release the Reset button when the Dynamic filter LEDs go off (after three flashes). To clear all the filters, do not release the Reset button until all the filters LEDs go off (approximately 7 flashes). **A full reset is recommended whenever you change speaker or microphone positions.** NOTE: Factory default is 6 Fixed and 2 Dynamic filters, so if you reset Dynamics only those two lights will go out during reset. And remember, whenever you perform a full reset you will automatically be in Turbo mode.

**WARNING: Do not reset all filters during the program.** This releases all the feedback you eliminated during setup. Use extreme caution when resetting the Dynamic filters, because you may need those filters at that moment during the show.

## TURBO MODE SETUP

The **FBX-SOLO** incorporates Turbo Mode setup, which is indicated by a flashing red Clip LED. This lightning-quick setup feature cuts the time for FBX filter initialization to just a few seconds.

**NOTE:** The SOLO is set in Turbo Mode at the factory and automatically engages every time you reset filters. The SOLO automatically returns to normal program mode when the first dynamic filter is set, or when you press the front panel Lock Fixed button. All the filter LEDs will cycle to indicate that Turbo Mode is about to disengage.

**WARNING: Turbo Mode will cause distortion in your audio program — it is for setup only.** You must follow the setup procedure outlined in the next section, and do not play program during Turbo Setup Mode. Otherwise the FBX-SOLO will clip, and filters may be set improperly. (Clip level is set to the lowest level so the feedback clips quickly; therefore, your program will also be clipped in Turbo Mode. Be sure a Dynamic filter is set, and if one isn't, press the Lock Fixed button before your program begins.) **You'll know the FBX-SOLO is in Turbo Mode if the red Clip LED flashes and when no other signal level LEDs are lit.** You can manually override Turbo mode if necessary: Press Lock Fixed (the Lock Fixed light will turn on), then press it again. (Lock Fixed light will go out).

## MOBILE vs. STATIONARY MICROPHONES

One significant advantage offered by the Sabine family of FBX Feedback Exterminator products is their ability to adapt to changing acoustical relationships involving sound system components and various user applications. One major source of potential feedback problems arises in situations with wireless microphones, when the user of the wireless mic is moving around the stage/auditorium. As a microphone moves in a sound space, with varying degrees of proximity to the speakers and varying acoustic responses, feedback frequencies may shift. In such a situation, feedback-free mobility may be more important a concern than maximum system gain.

One method of setting FBX filters with mobile microphones is to turn a microphone on and walk around to the various possible microphone locations. At the

same time, raise the system gain and set the FBX filters one at a time.

In some situations, raising the number of dynamic filters (versus fixed FBX filters) may allow a second layer of defense against new feedback from new locations. However, in many mobile microphone set ups, fixed FBX filters will protect against feedback across the range of microphone mobility.

## INSTRUCTIONS FOR OPERATION

### SL820 SYSTEM INITIALIZING PROCEDURE

**Choose the input level.** Switch to **LO** for instrument or microphone in (use with low level inputs such as piezo mics); this provides a 30 dB boost in the FBX's input gain structure. Switch to **HI** for insert or line in (use with high level output instruments and signal processors).

**Choose the output level.** Switch to Unity when you want level in to equal level out. In the Unity setting the SL820 has a system gain of 1 (input = output level). Switch to Line (for line level out) if your signal needs pre-amplification. In the Line setting the gain is adjusted between 0 and +35 dB via the clip level adjust.

### SM820 SYSTEM INITIALIZING PROCEDURE

**Select Phantom Power ON/OFF.** Your SM820 is delivered from the factory with the phantom power function disabled. If you wish to use phantom power, you may enable the function by switching to "Phantom Power - ON" on the back panel. *The majority of low impedance **balanced** non-phantom-powered mics are wired to ignore phantom power. Check your microphone owner's manual for verification to avoid damage. The SM820 will not pass phantom power from the mixer to your mic channel and is for pre-fader channel input only.*

### SL820 & SM820 SETUP INSTRUCTIONS

Follow these steps to obtain the maximum gain before feedback without changing the tonal quality of your program. Set up only one SOLO at a time. The following instructions are for using the SOLO on a channel insert. For use with monitors, substitute monitor send and master monitor control for input channel level fader and mixer master output. Be sure to turn off the mains when initializing the SOLO in your monitor system.

# FBX SETUP INSTRUCTIONS

- 1** Place the speakers and microphones in the positions where they will be used during the program. Avoid placing microphones directly in front of speakers. If you are using a graphic EQ, adjust it only for the desired tonal qualities. **DO NOT NOTCH FOR FEEDBACK.**



- 2** Set the mixer master output, all channel level faders, and the monitors to minimum.

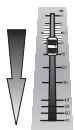

**OUTPUT,  
INPUT &  
MONITOR  
LEVELS**

- 3** Turn on the SOLO. Turn on the mixer, any signal processing equipment, and finally the power amp. **NOTE: compressors in the SOLO signal path should be off during this procedure.**



- 4** Press and hold the SOLO's Reset button (see page 8 for more details on the reset function) until the LEDs stop flashing to clear out all filters set previously.



**NOTE:** You are now in Turbo Mode (see page 9 for details). Be sure the "BY" LED is green to indicate the SOLO is not in bypass mode (red).



- 5** Turn the SOLO's clip level adjust to the two o'clock position.

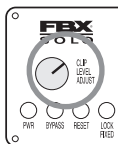

- 6** Set the mixer master output to a nominal level.

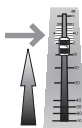

**MIXER MASTER**

**7** **Slowly** raise the input channel level fader for the channel being set until feedback occurs. The SOLO should quickly remove the feedback.

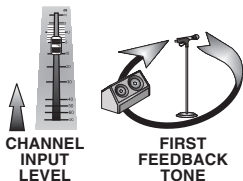

The first Filter LED will then blink to indicate a filter has been set.



**8** Keep raising the level **slowly** until all Fixed Filters and one dynamic filter is set. Turbo Setup Mode goes OFF automatically when the first Dynamic filter is initialized. Any un-initialized dynamic filters will be set later if feedback occurs during the program.

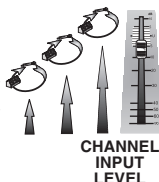

Now lower the channel level fader slightly so that the system is not on the verge of another feedback point. This is the maximum volume level that the FBX-SOLO will be able to provide. Higher levels will cause uncontrollable feedback.

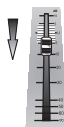

**9** Finally, during sound check, adjust the Clip Level Adjust so that the red Clip LED blinks intermittently, as you would adjust the recording level of a tape recorder. The unit will clip and distort the program if the Clip Level Adjust is set too high. If it is set too low, the signal-to-noise ratio will degrade and the system may hiss.



**IMPORTANT: Make sure Turbo mode is OFF — Clip LED NOT flashing!**

## HOW TO USE THE "LOCK FIXED" FEATURE

In certain situations the FBX may mistake music for feedback and drive the fixed filters deeper than necessary, like in a church with a pipe organ or during a performance with a great deal of intentional sustained electric guitar feedback. You may prevent the **fixed** filters from deepening beyond their initial depth by pressing the Lock Fixed button on the front panel **AFTER** setting the fixed filters as described previously. The Lock Fixed LED will light to indicate that the FBX is in Lock Fixed mode. The fixed filters will stay locked until you press the Lock Fixed button again. The dynamic filters are not affected. **In almost every situation, it is best to lock the fixed filters right after the initial setup.**

## LIMITING TOTAL NUMBER OF ACTIVE FILTERS

You may choose to limit the total number of active filters for each application by using the Lock Fixed button. For example, if you wish to use only three fixed and one dynamic filter, set the FBX so there are seven fixed and one dynamic filter. Then during the setup procedure, simply press the Lock Fixed button after setting the first three fixed filters. The remaining four fixed filters will be locked in their zero position.

## SELECTING FILTER WIDTH

If the SOLO is to be used for a music application, 1/10-octave filters are most effective. However, in spoken word applications, such as lectures or teleconferencing, the wider 1/5-octave filters are recommended. Select the filter width using the switch on the SOLO back panel. The change takes effect only on power-up. Selecting a new width has no effect unless you power down and then power up again.

## ENGAGING THE NOISE GATE

One outstanding feature of your FBX-SOLO is a user-selectable noise gate. It acts as an automatic switch that opens a microphone only when someone is speaking directly into it. A noise gate is especially useful in systems that have a number of open microphones, such as courtrooms, conference rooms, or parliament buildings. Gating microphones greatly reduces the number of possible feedback points in the room and allows for more system gain.

The level that turns the noise gate on and off is called the threshold. If the level coming into the gate is greater than the threshold, the noise gate opens, and the mic is turned on. If it is less than the threshold, the noise gate closes, and the mic is turned off.

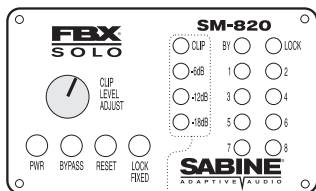

**Corresponding Noise Gate Threshold Levels:**

(To turn off the Noise Gate, press LOCK FIXED when the clip LEDs are off.)

- 24 dB
- 36 dB
- 48 dB
- 60 dB

You can adjust your SOLO to four different threshold levels (see diagram at left), or turn it off. To select the threshold, power down the SOLO. Hold in the Lock Fixed button, and power up the SOLO. The clip level LEDs will light in sequence. Select the threshold level by pressing the Lock Fixed button again when the clip LED lights at the corresponding threshold level. The noise gate is now enabled, indicated by a flashing level LED on power-up. **Pressing the Lock Fixed button with no clip LEDs lighted turns off the noise gate. If no lights flash on power-up, the noise gate is not engaged.** When the SOLO's noise gate is enabled, it will not become engaged until **after** you've set all fixed filters and one dynamic filter (if the SOLO is configured for any).

## USING SABINE'S OPTIONAL SOLO ACCESSORIES

**1-U rack tray (model # SL6RACK):** An optional 1-U rack tray holds up to six SOLOs (and/or Sabine's SDA102 digital delays). Mount the SL820s, SM820s, or a combination of both side by side on the tray. Use only Sabine supplied screws; use of any other screws may damage the SOLO and void the warranty.

## IMPORTANT OPERATING CONSIDERATIONS

**MEMORY:** The FBX stores the positions and depths of the filters in nonvolatile internal memory when the unit is turned off or during a power failure. The unit will return all filters to their previous frequencies and depths when it is turned back on.

**BYPASS MODE:** Placing the FBX-SOLO in bypass mode only shuts down the FBX function; the micro-

phone preamp still functions when the unit is in bypass mode. The SOLO will not pass signal if the power is off in either active or bypass mode.

**RESETTING THE FILTERS:** You must reset the FBX if the microphones or speakers are moved significantly.

**To reset ALL filters:** press and hold the reset button until the filter LEDs flash about 7 times, or until all filter LEDs turn off.

**To reset only the dynamic filters:** press and hold the reset button for 3 flashes and let go. The LEDs that indicate current dynamic filter placement will be off, and the fixed filter LEDs will remain on.

## TROUBLESHOOTING TIPS

**Q.** Can I patch the SOLO SL820 after the mixer and before the power amp?

**A.** Yes, but only in cases where just eight feedback filters are needed, such as on the monitors alone. Eight FBX filters may not always provide enough gain before feedback for your entire mix.

**Q.** Sometimes I don't get enough gain before feedback. Why?

**A.** Gain before feedback is determined by the number of fixed filters you set; increasing the number of fixed filters during setup increases the system's gain before feedback. Fixed filters are set automatically during the initial setup and remain on the initially detected feedback tone -- they do not move. You can reconfigure the filters from the factory default setting (six fixed and two dynamic) to any combination of fixed and dynamic filters. Review the procedure on page 10, UNDERSTANDING FIXED AND DYNAMIC FILTERS of this operating guide.

**Q.** The Clip Level LEDs do not light. The unit will not catch feedback. Why?

**A.** The unit is not in the signal path. Check the connections.

**Q.** Why does one of the Filter Activity LEDs blink?

**A.** The last filter to be automatically updated blinks. During normal operation, the blinking will move from filter to filter as the SOLO finds new feedback points. This gives the user a visual confirmation that the unit is functioning properly.

- Q.** Why does my SOLO set filters when music is played through it?
- A.** Make sure the FBX's Turbo Mode has turned off before you program. Check the signal level ladder. If the red Clip LED lights with no other signal level LEDs lit, the FBX-SOLO is still in Turbo Mode. Turbo Mode turns off automatically after the first dynamic filter is set, or you can turn it off manually by pressing the Lock Fixed button. Turbo Mode sets filters very quickly — without analyzing the signal — and may not distinguish feedback from music or audio signal.
- Q.** Why would the FBX cause a noticeable hum?
- A.** It may hum if the system is improperly grounded. Check for bad grounds.
- Q.** Why does my system sound thin and muffled?
- A.** Place the SOLO in Bypass Mode. If the system still sounds thin, your problem is probably with improper use of a graphic EQ. If the problem exists only with the SOLO in Active mode, verify the clip level setting, reinitialize the system and lock the fixed filters.
- Q.** With the SL820 in the insert point, I hear no audio. Why?
- A.** Your insert point may be wired opposite to the SOLO. Try reversing the tip and ring (in and out) of your Y-cord. If you are using a single TRS cable, you will have to reconfigure one end of it to conform to your mixer insert point.
- Q.** Will the SOLO eliminate feedback in both mains and monitors?
- A.** Yes, but for maximum gain you should set as many fixed filters as possible on the system with the most feedback problems. Choose which system is more likely to have feedback, and follow the system initializing procedure for either mains or monitors. During program, the dynamic filters will control feedback for both mains and monitors if they are in use, but only on the input channel the SOLO is patched into.
- Q.** The channel I have the SOLO in seems noisy. What can I do?
- A.** If the noise floor is too high, you need to readjust the gain structure of that channel. Follow the SOLO initialization instructions in this guide.

# PRODUCT SPECIFICATIONS

## FILTERS

Eight independent digital notch filters controlled automatically from 40 Hz to 20 KHz

**Filter width:** 1/10 octave, typical, or 1/5-oct. selectable; constant "Q"

**Filter depth:** DSP controlled, variable to -50 dB

**Resolution:** 1/50th octave

**Time required to find and eliminate feedback:** 0.4 sec., typical @ 1 KHz

**Total number of combined filters active:** User selectable, from 1-8

**Number of Dynamic vs. Fixed filters:** User selectable

Last configuration stored in memory

## INPUT/OUTPUT - SL820 ONLY

**I/O Connectors:** 1/4" TRS; tip = input, ring = output, sleeve = ground

**Input Impedance:** Unbalanced >1 meg Ohm

**Output Impedance:** Unbalanced 10 Ohms nominal; Maximum load 2K Ohms

**Maximum Input/Output Level at lowest gain:** +20 dBV

**Gain Range (with line out selected):** 0 to +35 dB (high in), +30 to +65 dB (low in)

**Input to Output Gain @ unity setting:** +/- 0.5 dBV

**Bypass:** Digital

## INPUT/OUTPUT - SM820 ONLY

**I/O Connectors:** XLR-3 PIN 2 high Balanced

**Input Impedance:** 1K Ohm nominal

**Output Impedance:** Unbalanced 10 Ohms nominal; Maximum load 2K Ohms

**Maximum Input/Output Level at lowest gain:** -10 dBV\*\*

**Gain Range:** -15 to +20 dB (at high output)

**Input to Output Gain @ unity setting:** +/- 0.5 dBV

**Bypass:** Digital

**EIN:** -105 dBm @ 150 Ohms, 20 Hz - 20 KHz or better

**Phantom Power:** 48V switch selectable

## **PERFORMANCE\*\*\***

**Frequency Response:** < +0.75 dB, 20 Hz to 20 KHz

**Signal to Noise Ratio:** >94 dB typical

**Total Harmonic Distortion:** <0.01% @ 1 KHz @ +15 dBV

**Dynamic Range:** >100 dB

## **NOISE GATE**

**Attack Time:** Fixed (400 mS)

**Threshold:** Selectable (-24 dB, -36 dB, -48 dB, -60 dB)

## **POWER SUPPLY**

8-20 VDC @ 400 mA

## **DIMENSIONS**

1-U height, 1/6-RU width; 2.78 x 1.65 x 5.5 in. (6.95 x 4.13 x 13.75 cm)

## **WEIGHT**

9 oz. (0.26 kg)

## **OPTIONS**

SL6RACK Rack Tray (holds up to six units)

---

\*Below approximately 200 Hz the feedback filters become slightly wider to increase the capture speed of feedback and rumble at these low frequencies.

\*\*Note: Inputs may be balanced or unbalanced.

\*\*\*Tests performed using an Audio Precision System One model 322 or equal.

**SPECIFICATIONS SUBJECT TO CHANGE WITHOUT NOTICE.**



# CAUTION



EXPOSURE TO EXTREMELY HIGH NOISE LEVELS MAY CAUSE A PERMANENT HEARING LOSS. INDIVIDUALS VARY CONSIDERABLY IN SUSCEPTIBILITY TO NOISE INDUCED HEARING LOSS, BUT NEARLY EVERYONE WILL LOSE SOME HEARING IF EXPOSED TO SUFFICIENTLY INTENSE NOISE FOR A SUFFICIENT TIME. THE U.S. GOVERNMENT'S OCCUPATIONAL SAFETY AND HEALTH ADMINISTRATION (OSHA) HAS SPECIFIED THE FOLLOWING PERMISSIBLE NOISE LEVEL EXPOSURES:

DURATION/DAY IN HOURS	SOUND LEVEL IN dBA, SLOW RESPONSE	DURATION/DAY IN HOURS	SOUND LEVEL IN dBA, SLOW RESPONSE
8	90	1-1/2	102
6	92	1	105
4	95	1/2	110
3	97	1/4 or less	115
2	100		

ACCORDING TO OSHA, ANY EXPOSURE IN EXCESS OF THE ABOVE PERMISSIBLE LIMITS COULD RESULT IN HEARING LOSS. EAR PLUGS OR PROTECTORS IN THE EAR CANALS OR OVER THE EARS MUST BE WORN WHEN OPERATING THIS DEVICE IN ORDER TO PREVENT A PERMANENT HEARING LOSS. IF EXPOSURE IS IN EXCESS OF THE LIMITS AS SET FORTH ABOVE, TO ENSURE AGAINST POTENTIALLY DANGEROUS EXPOSURE TO HIGH SOUND PRESSURE LEVELS, IT IS RECOMMENDED THAT ALL PERSONS EXPOSED TO EQUIPMENT CAPABLE OF PRODUCING HIGH SOUND PRESSURE LEVELS SUCH AS THIS DEVICE BE PROTECTED BY HEARING PROTECTORS WHILE THIS UNIT IS IN OPERATION.

1. Read all safety and operating instructions before using this product.
2. All safety and operating instructions should be retained for future reference.
3. Obey all cautions in the operating instructions and on the unit.
4. All operating instructions should be followed.
5. Use only shielded audio and data cables.
6. This product should not be used in the presence of moisture or rain, or near any water, i.e., a bathtub, sink, swimming pool, wet basement, etc.
7. This product should be located so that its position does not interfere with proper ventilation. Do not use in direct sunlight. Do not place flat against a wall or in a built-in enclosure that will impede the flow of cooling air.
8. This product should not be placed near a source of heat such as a stove or radiator.
9. Connect only to a power supply of the type marked on the unit adjacent to the power entry module.
10. Never break off the ground pin on the power supply cord.
11. Power supply cords should always be handled carefully. Never walk or place equipment on power supply cords. Periodically check cords for cuts or signs of stress, especially at the plug and the point where the cord exits the unit.
12. The power supply cord should be unplugged when the unit is to be unused for long periods of time.
13. Care should be taken so that objects do not fall and liquids are not spilled into the unit through the ventilation holes or any other openings.
14. This unit should be checked by a qualified service technician if:
  - A. The power supply cord or plug has been damaged.
  - B. Anything has fallen or been spilled into the unit.
  - C. The unit does not operate correctly.
  - D. The unit has been dropped or the enclosure damaged.
15. The user should not attempt to service this equipment. All service work should be done by a qualified service technician.

OSHA 2201; 1995 revised.

## FCC STATEMENT

*Warning:* Changes or modifications to this unit not expressly approved by the party responsible for compliance could void the user's authority to operate the equipment.

This device complies with Part 15, Class B, of the FCC Rules. Operation is subject to the following conditions: (1) This device may not cause harmful interference; and (2) This device must accept any interference received, including interference that may cause undesired operation.

NOTE: This equipment has been tested and found to comply with the limits for a Class B digital device, pursuant to Part 15 of the FCC Rules. These limits are designed to provide reasonable protection against harmful interference in a residential installation. This equipment generates, uses, and can radiate radio frequency energy and, if not installed and used in accordance with the instructions, may cause harmful interference to radio communications. However, there is no guarantee that interference will not occur in a particular installation. If this equipment does cause harmful interference to radio or television reception, which can be determined by turning the equipment off and on, the user is encouraged to try to correct the interference by one or more of the following measures:

- Reorient or relocate the receiving antenna.
- Increase the separation between the equipment and receiver.
- Connect the equipment into an outlet on a circuit different from that to which the receiver is connected.
- Consult the dealer or an experienced radio TV technician for help.

This digital apparatus does not exceed the Class B limits for radio noise emissions from digital apparatus set out in the Radio Interference Regulations of the Canadian Department of Communications.

Le present appareil numerique n'emet pas de bruits radioelectriques depassant les limites applicables aux appareils numeriques de la class B prescrites dans le Reglement sur le brouillage radioelectrique edicte par le ministere des Communications du Canada.

### Japanese EMI Statement:

この装置は、第二種情報装置  
(住宅地域又はその隣接した地域において使用されるべき情報装置)  
で住宅地域での電波障害防止を目的とした情報処理装置等電波障害  
自主規制協議会 (VCCI) 基準に適合しております。  
しかし、本装置をラジオ、テレビジョン受信機に近接してご使用に  
なると、受信障害の原因となることがあります。  
取扱説明書に従って正しい取り扱いをして下さい。



Only when used with the following Sabine-supplied power modules:

- AD 1280-100
- AD 1280-120
- AD 1280-230
- AD 1280-240A
- AD 1280-240U

# ONE-YEAR LIMITED WARRANTY:

**THIS LIMITED WARRANTY VALID ONLY WHEN PURCHASED AND REGISTERED IN THE UNITED STATES OR CANADA. ALL EXPORTED PRODUCTS ARE SUBJECT TO WARRANTY AND SERVICES TO BE SPECIFIED AND PROVIDED BY THE AUTHORIZED DISTRIBUTOR FOR EACH COUNTRY.**

Ces clauses de garantie ne sont valables qu'aux Etats-Unis et au Canada. Dans tous les autres pays, les clauses de garantie et de maintenance sont fixées par le distributeur national et assurées par lui selon la législation en vigueur.

Diese Garantie ist nur in den USA und Kanada gültig. Alle Export-Produkte sind der Garantie und dem Service des Importeurs des jeweiligen Landes unterworfen.

Esta garantía es válida solamente cuando el producto es comprado en E.U. continentales o en Canada. Todos los productos que sean comprados en el extranjero, están sujetos a las garantías y servicio que cada distribuidor autorizado determine y otorga en los diferentes países.

## **ONE-YEAR LIMITED WARRANTY/REMEDY**

SABINE, INC. ("SABINE") warrants this product to be free from defects in material and workmanship for a period of one (1) year from date of purchase PROVIDED, however, that this limited warranty is extended only to the original retail purchaser and is subject to the conditions, exclusions and limitations hereinafter set forth:

## **CONDITIONS, EXCLUSIONS AND LIMITATIONS OF LIMITED WARRANTIES**

These limited warranties shall be void and of no effect if:

- a. The first purchase of the product is for the purpose of resale; or
- b. The original retail purchase is not made from an AUTHORIZED SABINE DEALER; or
- c. The product has been damaged by accident or unreasonable use, neglect, improper service or maintenance, or other causes not arising out of defects in material or workmanship; or
- d. The serial number affixed to the product is altered, defaced or removed; or
- e. The power supply grounding pin is removed or otherwise defeated. In the event of a defect in material and/or workmanship covered by this limited warranty, Sabine will repair the defect in material or workmanship or replace the product, at Sabine's option; and provided, however, that, in any case, all costs of shipping, if necessary, are paid by you, the purchaser.

**THE WARRANTY REGISTRATION CARD SHOULD BE ACCURATELY COMPLETED, MAILED TO AND RECEIVED BY SABINE WITHIN FOURTEEN (14) DAYS FROM THE DATE OF YOUR PURCHASE.**

In order to obtain service under these warranties, you must:

- a. Bring the defective item to any AUTHORIZED SABINE DEALER and present therewith the ORIGINAL PROOF OF PURCHASE supplied to you by the AUTHORIZED SABINE DEALER in connection with your purchase from him of this product. If the DEALER is unable to provide the necessary warranty service, you will be directed to the nearest other SABINE AUTHORIZED DEALER which can provide such service. **OR**
- b. Call Sabine for a RETURN AUTHORIZATION NUMBER and ship the defective item, prepaid, to:

**SABINE, INC. 13301 HIGHWAY 441  
ALACHUA, FL 32615-8544 USA**

including therewith a complete, detailed description of the problem, together with a legible copy of the original PROOF OF PURCHASE and a complete return address. Upon Sabine's receipt of these items:

If the defect is remedial under the limited warranties and the other terms and conditions expressed have been complied with, Sabine will provide the necessary warranty service to repair or replace the product and will return it, FREIGHT COLLECT, to you, the purchaser.

Sabine's liability to the purchaser for damages from any cause whatsoever and regardless of the form of action, including negligence, is limited to the actual damages up to the greater of \$500.00 or an amount equal to the purchase price of the product that caused the damage or that is the subject of or is directly related to the cause of action. Such purchase price will be that in effect for the specific product when the cause of action arose. This limitation of liability will not apply to claims for personal injury or damage to real property or tangible personal property allegedly caused by Sabine's negligence. Sabine does not assume liability for personal injury or property damage arising out of or caused by a non-Sabine alteration or attachment, nor does Sabine assume any responsibility for damage to interconnected non-Sabine equipment that may result from the normal functioning and maintenance of the Sabine equipment.

**UNDER NO CIRCUMSTANCES WILL SABINE BE LIABLE FOR ANY LOST PROFITS, LOST SAVINGS, ANY INCIDENTAL DAMAGES OR ANY CONSEQUENTIAL DAMAGES ARISING OUT OF THE USE OR INABILITY TO USE THE PRODUCT, EVEN IF SABINE HAS BEEN ADVISED OF THE POSSIBILITY OF SUCH DAMAGES.**

THESE LIMITED WARRANTIES ARE IN LIEU OF ANY AND ALL WARRANTIES, EXPRESS OR IMPLIED, INCLUDING BUT NOT LIMITED TO, THE IMPLIED WARRANTIES OF MERCHANTABILITY AND FITNESS FOR A PARTICULAR USE; PROVIDED, HOWEVER, THAT IF THE OTHER TERMS AND CONDITIONS NECESSARY TO THE EXISTENCE OF THE EXPRESS LIMITED WARRANTIES, AS HEREINABOVE STATED, HAVE BEEN COMPLIED WITH, IMPLIED WARRANTIES ARE NOT DISCLAIMED DURING THE APPLICABLE ONE-YEAR PERIOD FROM DATE OF PURCHASE OF THIS PRODUCT.

SOME STATES DO NOT ALLOW LIMITATION ON HOW LONG AN IMPLIED WARRANTY LASTS, OR THE EXCLUSION OR LIMITATION OF INCIDENTAL OR CONSEQUENTIAL DAMAGES, SO THE ABOVE LIMITATIONS OR EXCLUSIONS MAY NOT APPLY TO YOU. THESE LIMITED WARRANTIES GIVE YOU SPECIFIC LEGAL RIGHTS, AND YOU MAY ALSO HAVE OTHER RIGHTS WHICH MAY VARY FROM STATE TO STATE.

THESE LIMITED WARRANTIES ARE THE ONLY EXPRESS WARRANTIES ON THIS PRODUCT, AND NO OTHER STATEMENT, REPRESENTATION, WARRANTY OR AGREEMENT BY ANY PERSON SHALL BE VALID OR BINDING UPON SABINE.

In the event of any modification or disclaimer of express or implied warranties, or any limitation of remedies, contained herein conflicts with applicable law, then such modification, disclaimer or limitation, as the case may be, shall be deemed to be modified to the extent necessary to comply with such law.

Your remedies for breach of these warranties are limited to those remedies provided herein, and Sabine gives this limited warranty only with respect to equipment purchased in the United States of America.

## **INSTRUCTIONS-WARRANTY REGISTRATION CARD**

1. Mail the completed WARRANTY REGISTRATION CARD to:

**SABINE, INC. 13301 Highway 441  
ALACHUA, FL 32615-8544 USA**

- a. Keep the PROOF OF PURCHASE. In the event warranty service is required during the warranty period, you will need this document. **There will be no identification card issued by Sabine, Inc.**

## **2. IMPORTANCE OF WARRANTY REGISTRATION CARDS AND NOTIFICATION OF CHANGES OF ADDRESS:**

- a. Completion and mailing of WARRANTY REGISTRATION CARDS - Should notification become necessary for any condition that may require correction, the REGISTRATION CARD will help ensure that you are contacted and properly notified.

- b. Notice of address changes - If you move from the address shown on the WARRANTY REGISTRATION CARD, you should notify Sabine of the change of address so as to facilitate your receipt of any bulletins or other forms of notification which may become necessary in connection with any condition that may require dissemination of information or correction.

3. You may contact Sabine directly by telephoning (386) 418-2000.

4. Please have the Sabine product name and serial number available when communicating with Sabine Customer Service.

**REGISTER YOUR SABINE  
PRODUCT ONLINE AT  
WWW.SABINE.COM**



**Manufactured by: Sabine, Inc.**

**13301 NW US Highway 441**

**Alachua, Florida 32615-8544 USA**

**+USA (386) 418-2000 • Fax: +USA (386) 418-2001**

**[www.Sabine.com](http://www.Sabine.com)**

---

FBX® and FBX Feedback Exterminator® are registered trademarks of Sabine, Inc., and are the brand names of its line of automatic feedback controllers. Covered by U.S. Patent No. 5,245,665, Australian Patent No. 653,736, Canadian Patent No. 2,066,624-2, German Patent No. 69118486.0, and British Patent No. 0486679. Other patents pending.

